

## i-Tips

### Standard

ERSADUR Lötspitzenserie 102 passend zu LötKolben

i-TOOL PICO (0130CDK), i-TOOL NANO (0120CDK) und i-TOOL (0100CDJ)

ERSADUR soldering tip series 102 for soldering irons

i-TOOL PICO (0130CDK), i-TOOL NANO (0120CDK) and i-TOOL (0100CDJ)

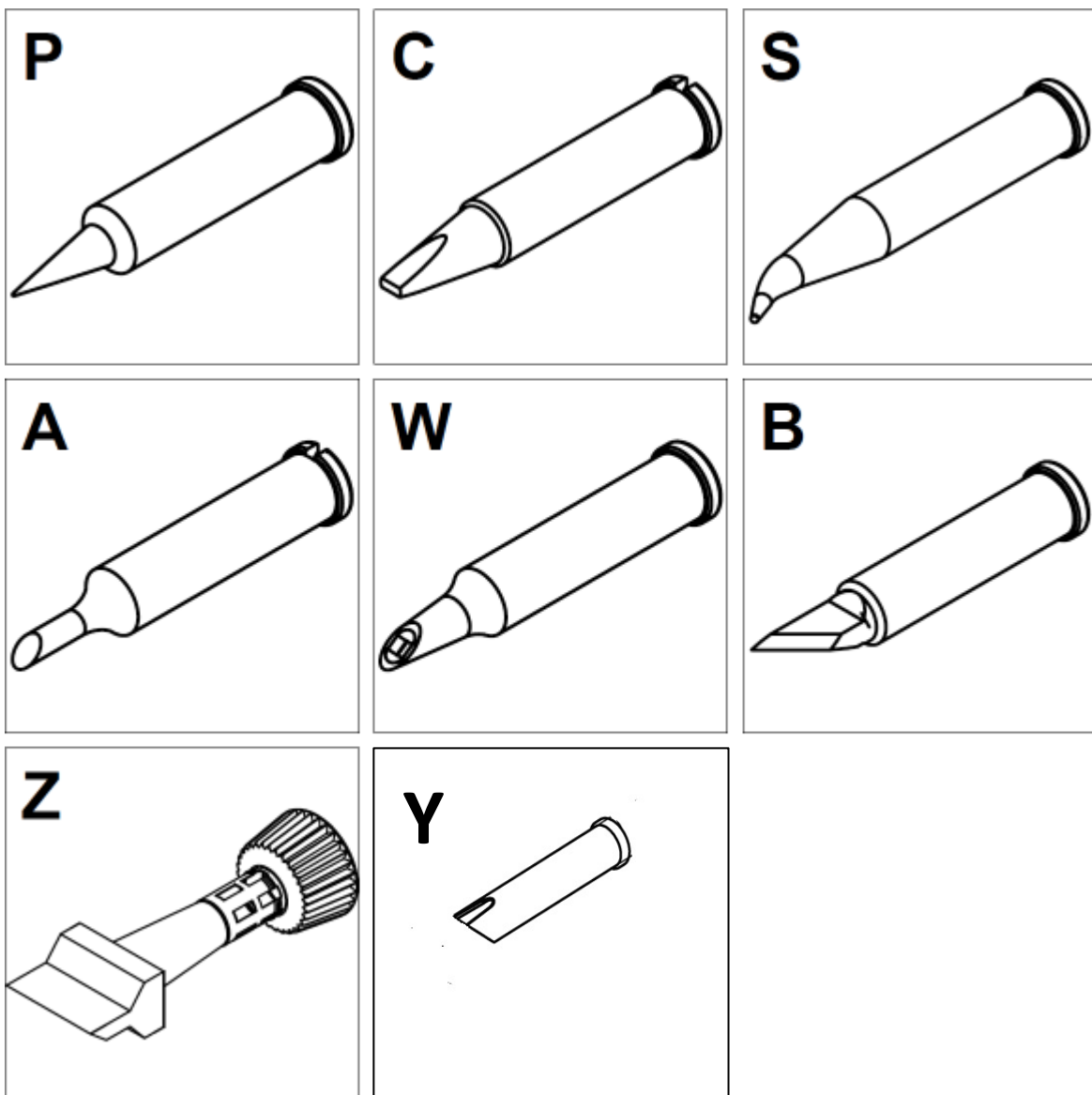

# i-Tips

## Standard

### i-Tips P (bleistiftspitz / pencil point)

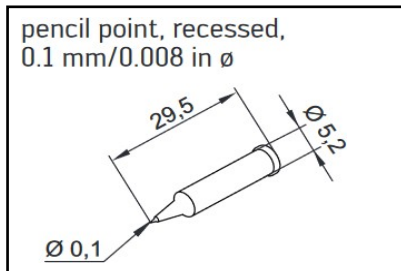

**0102PDLF01**

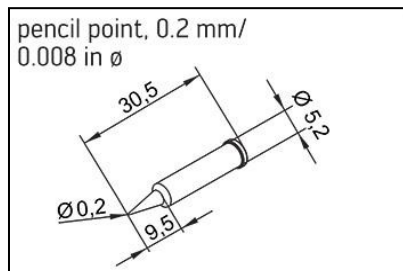

**0102PDLF02**

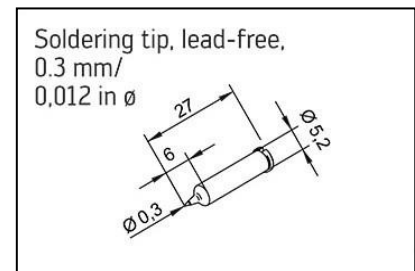

**0102PDLF03**

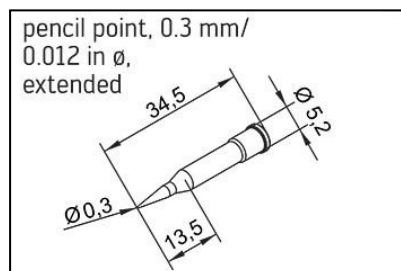

**0102PDLF03L**

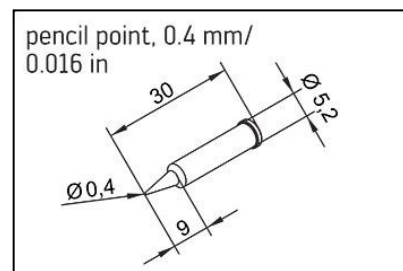

**0102PDLF04**

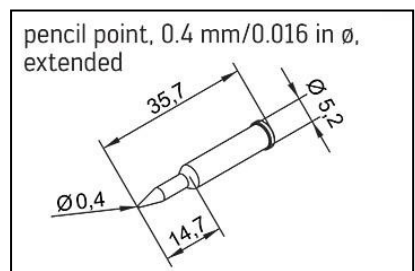

**0102PDLF04L**

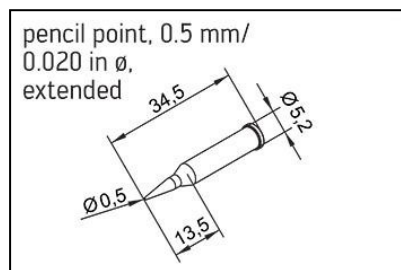

**0102PDLF05L**

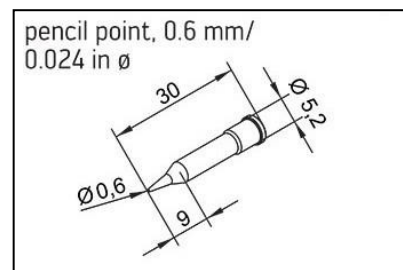

**0102PDLF06**

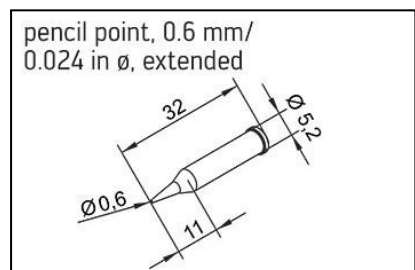

**0102PDLF06L**

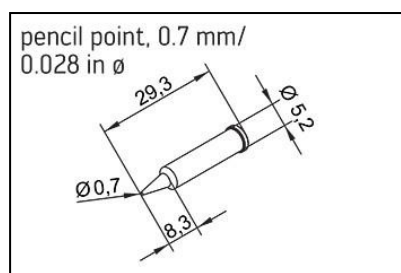

**0102PDLF07**

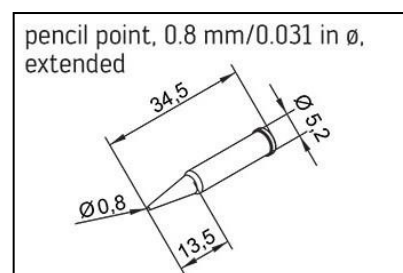

**0102PDLF08L**

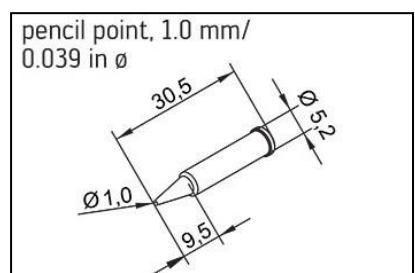

**0102PDLF10**

Alle Maße ohne Vorverzinnung / all dimensions without pre-tinning

ERSA GmbH

# i-Tips

## Standard

### i-Tips C (meißelförmig / chisel shaped)

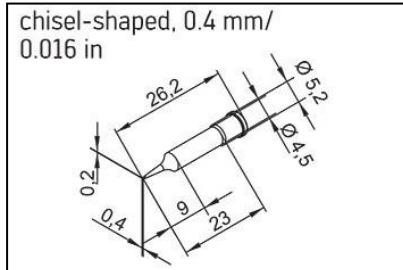

**0102CDLF04**

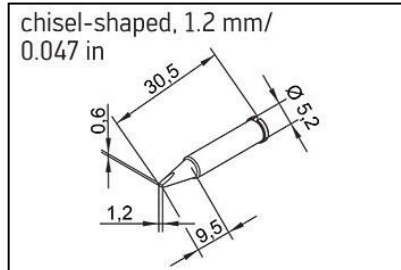

**0102CDLF12**

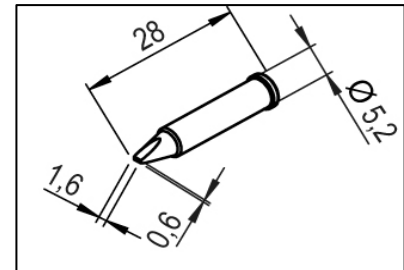

**0102CDLF16**

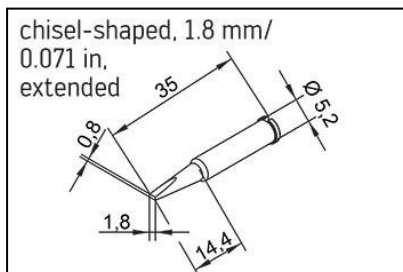

**0102CDLF18L**

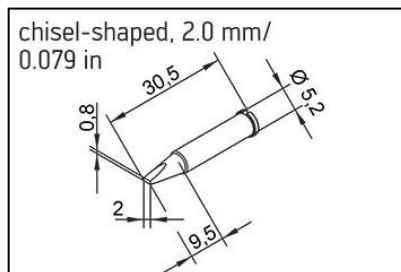

**0102CDLF20**

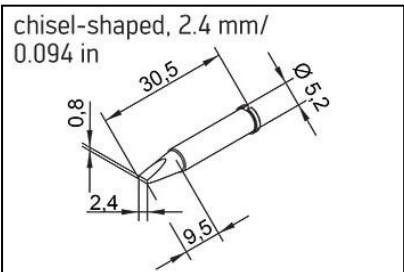

**0102CDLF24**

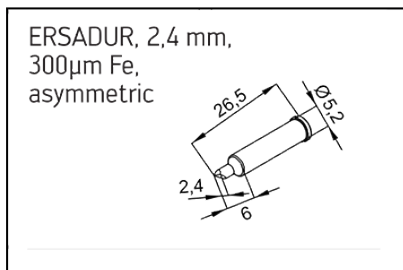

**0102CDLF24A**

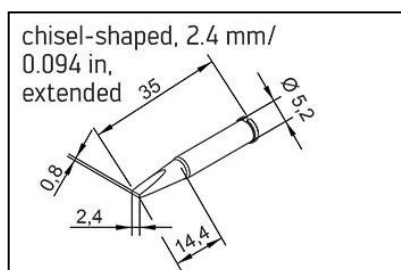

**0102CDLF24L**

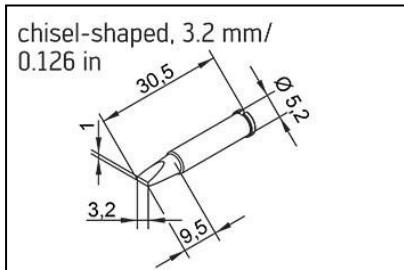

**0102CDLF32**

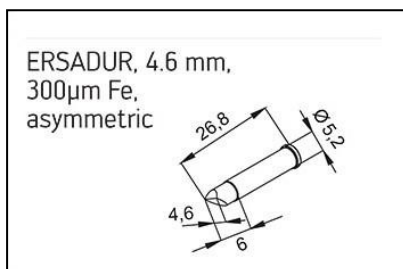

**0102CDLF46A**

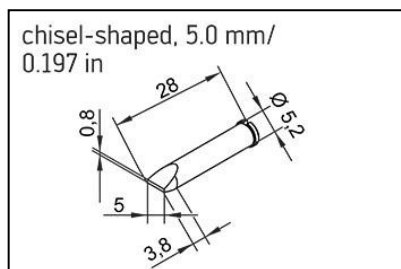

**0102CDLF50**

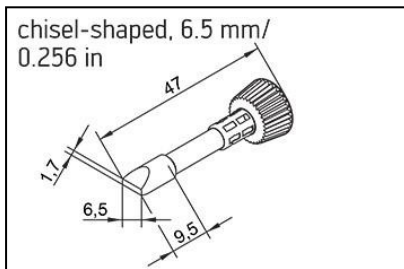

**0102CDLF65**

Alle Maße ohne Vorverzinnung / all dimensions without pre-tinning

# i-Tips

## Standard

### i-Tips C (meißelförmig / chisel shaped)

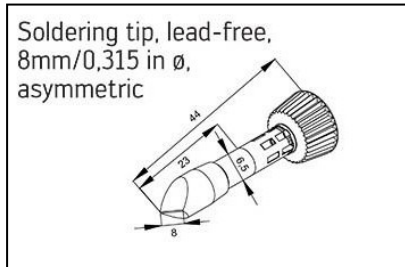

**0102CDLF80A**

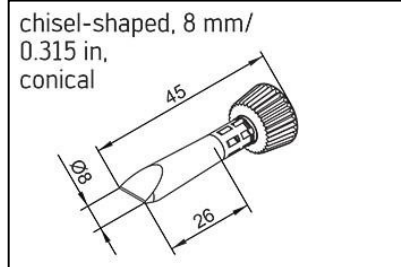

**0102CDLF080C**

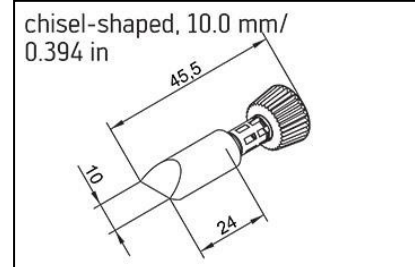

**0102CDLF100**

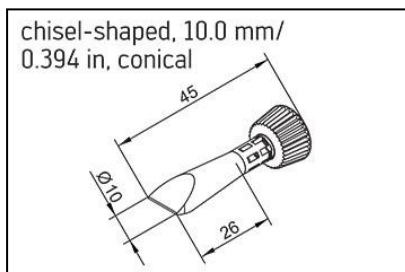

**0102CDLF100C**

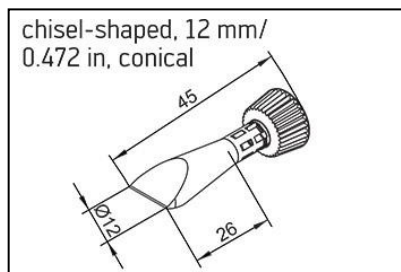

**0102CDLF120C**

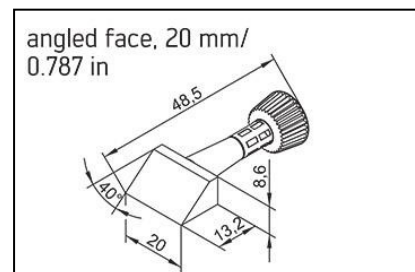

**0102CDLF200**

### i-Tips S (gebogen / bent)

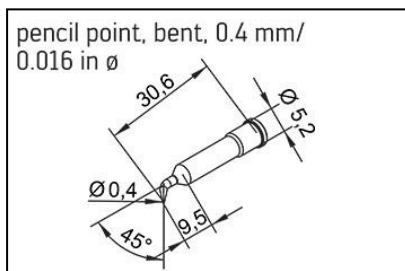

**0102SDLF04**

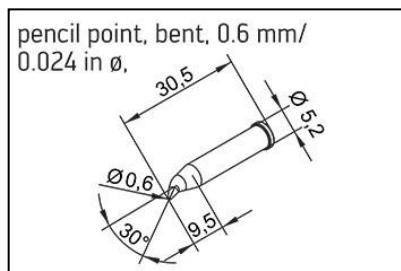

**0102SDLF06**

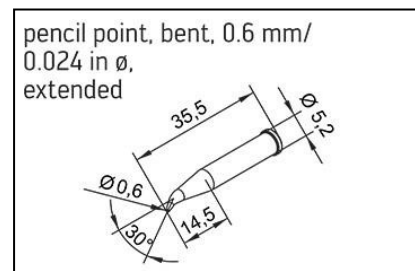

**0102SDLF06L**

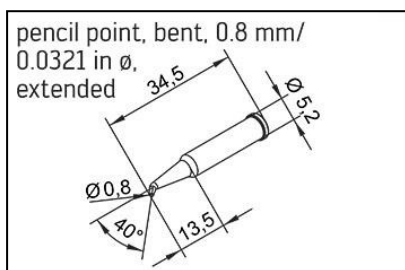

**0102SDLF08L**

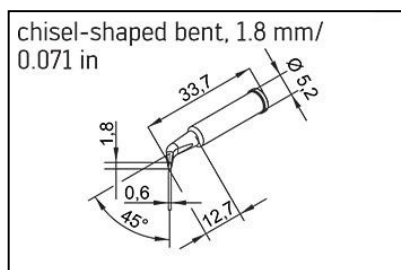

**0102SDLF18**

Alle Maße ohne Vorverzinnung / all dimensions without pre-tinning

ERSA GmbH

# i-Tips

Standard

## i-Tips A (angeschrägt/ angled face)

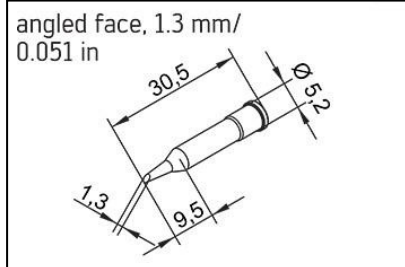

0102ADLF13

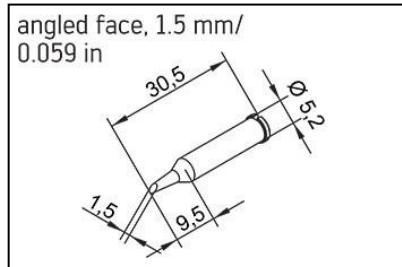

0102ADLF15

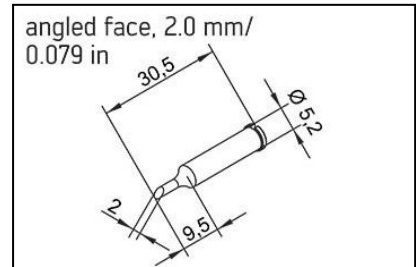

0102ADLF20

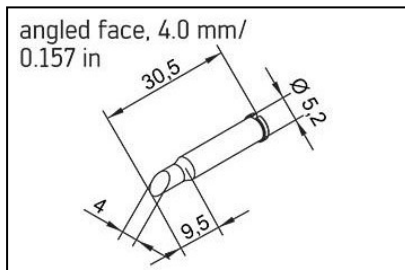

0102ADLF40

## i-Tips W PowerWell (mit Hohlkehle / with concave portion)

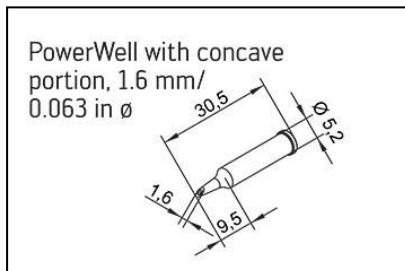

0102WDLF16

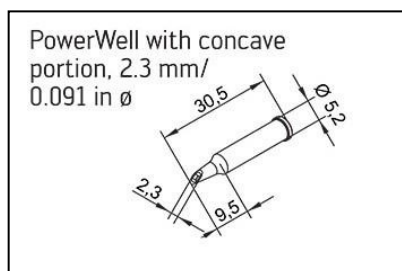

0102WDLF23

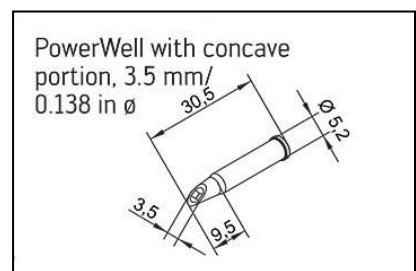

0102WDLF35

## i-Tip B (PLCC Messer / PLCC blade)

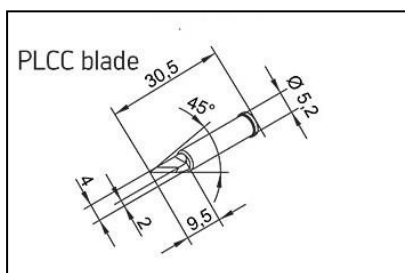

0102BDLF20

# i-Tips

Standard

## i-Tips Z (Wick-Tip)

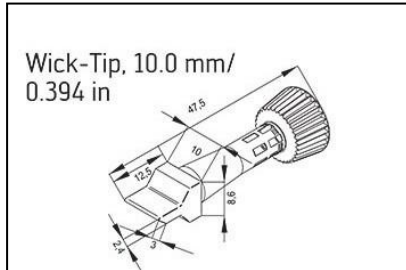

0102ZDLF100

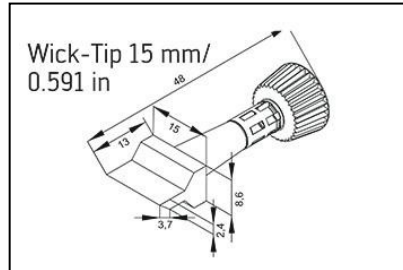

0102ZDLF150

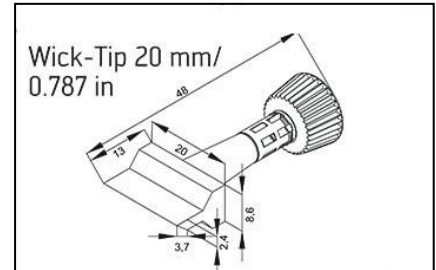

0102ZDLF200

## i-Tips Y (Kuhfuß / Cow Claw)

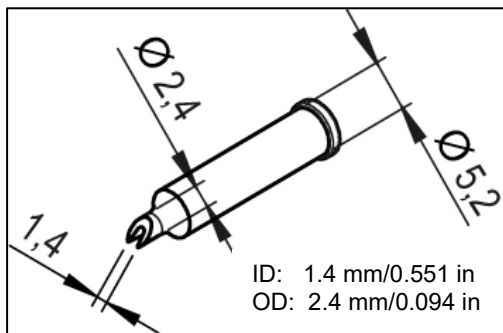

0102YDLF1224

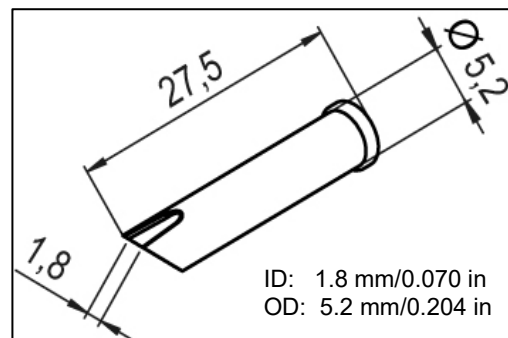

0102YDLF1852